

# La CLOCHE GFM

(Pěchotní zvon AJ/N)

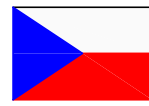

Fortification tchèque de l'époque 1935-1938

Casemate d'infanterie

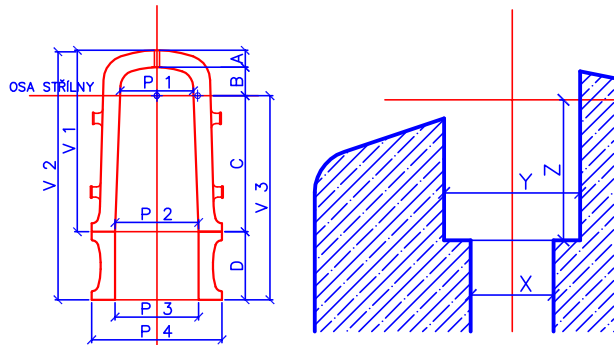
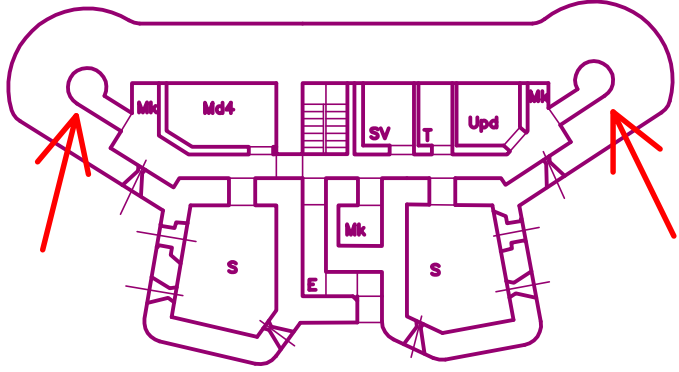

Dimensions générales pour placement

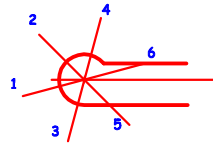

Façon de béton

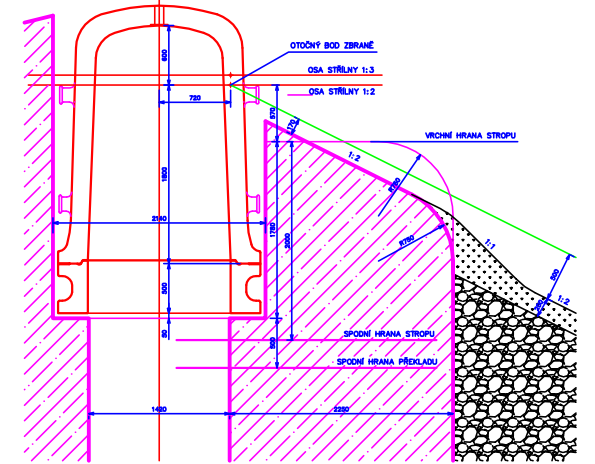

Dimensions pour fabrication

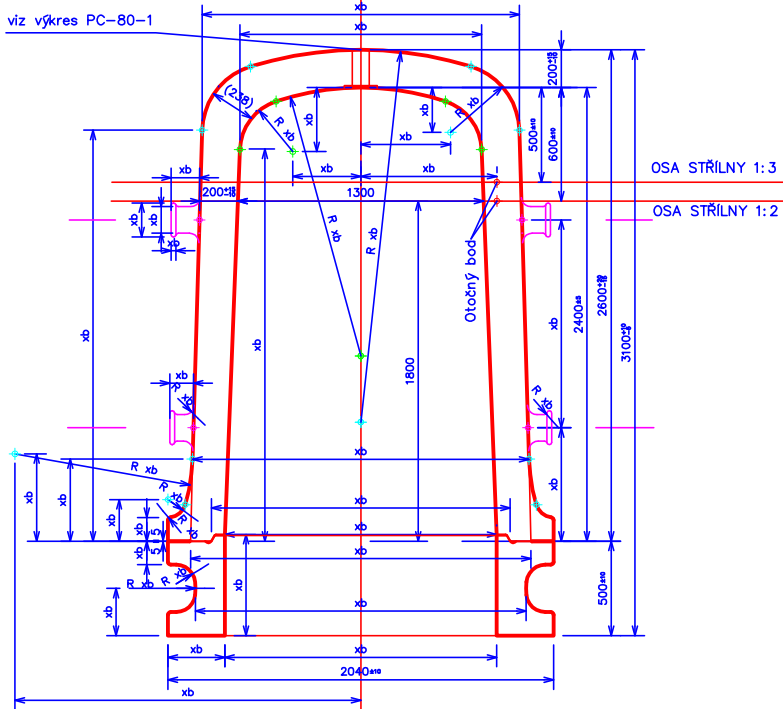

Créneau – cadre fixe pour élévation 15° et dépression 1:2

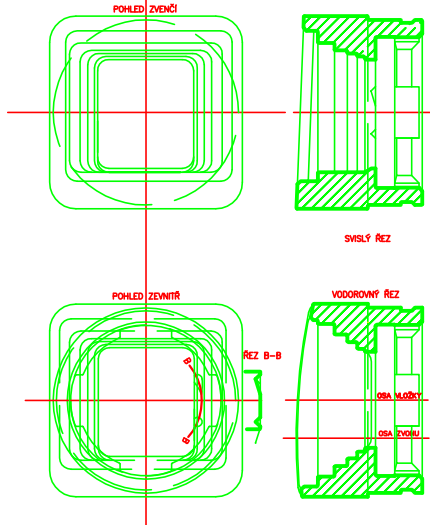

Muraille de la cloche – orifice pour cadre fixe

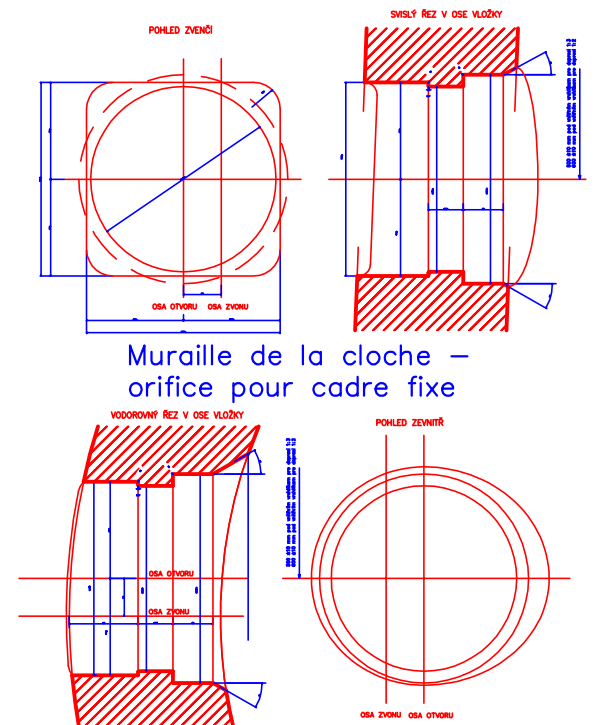

Installation de FM pour dépression 1:2

Installation de FM pour dépression 1:3

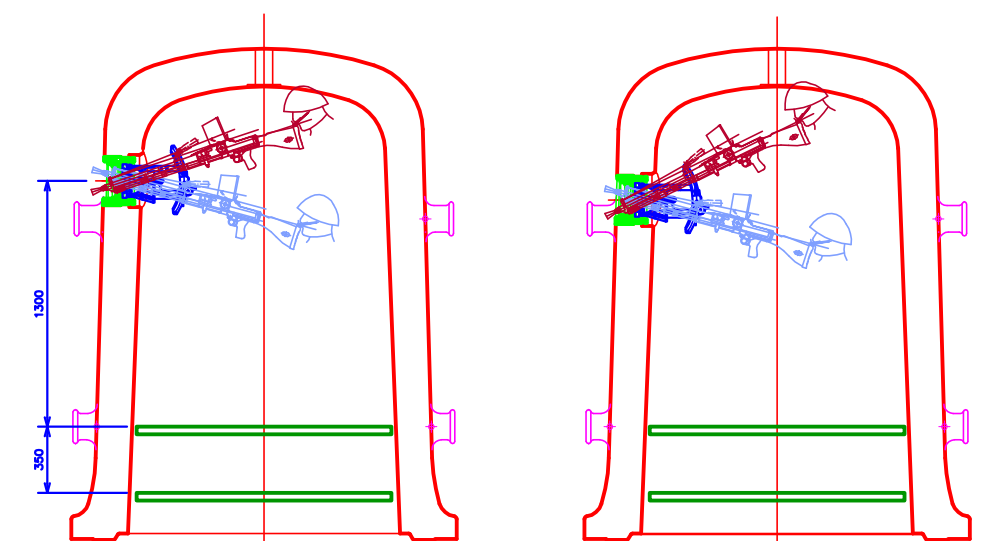
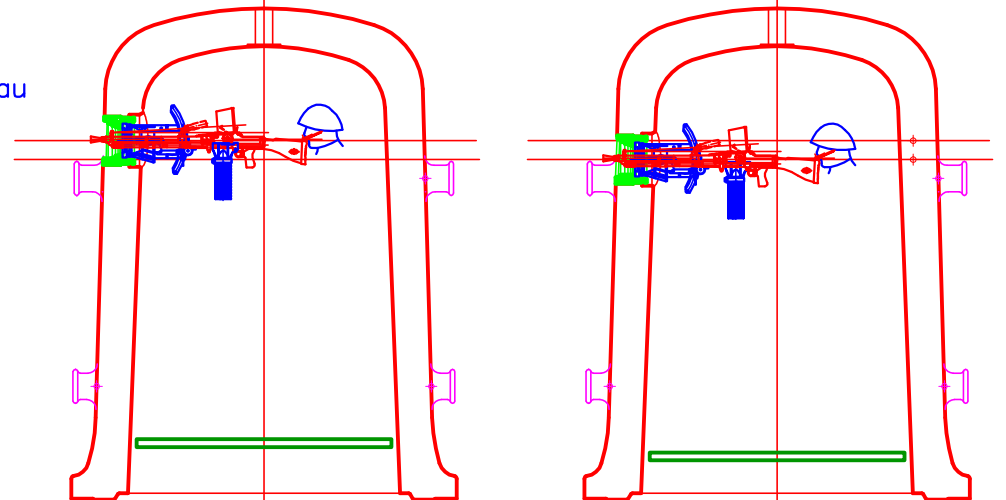

Pointage vertical pour 15°/1:3

Pointage vertical pour 15°/1:2

Fusil mitrailleur Mle 1926

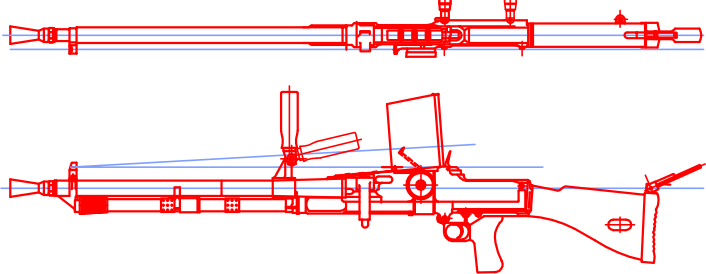

Affût Mle 1937 et descente des douilles

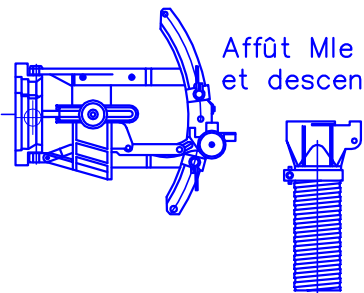

Assemblage de créneau

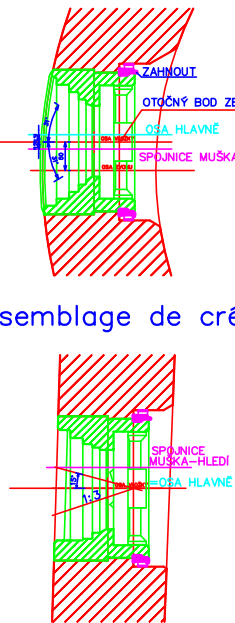

Tireur dans cloche

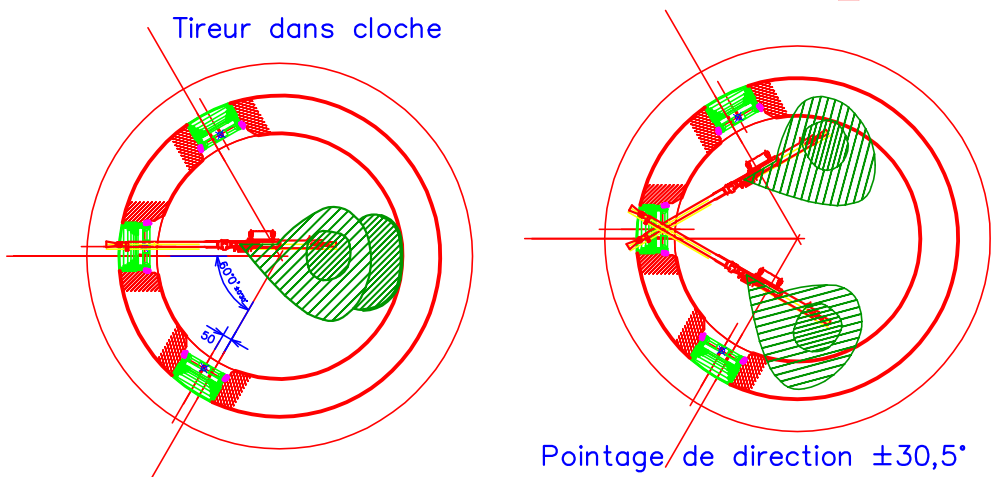

Pointage de direction ±30,5°

Doplňuje výkres	Nahrazuje výkres	Nahrázen výkresem		
KRESLIL	Michal Prátil			
NÁZEV CELKU	AJ – JA			
NÁZEV OBJEKTU	Cloche GFM modèle S allongé (pour dépression 1:3 et 1:2)			
Název a číslo (doména 1:2 a 1:3)			DATUM	27. 6. 2009
			FORMÁT	B A4
			MĚŘÍTKO	–
NÁZEV VÝKRESU	DESSIN GÉNÉRAL		ČÍS. VÝKRESU	V-080309f